

# VERLEGEANLEITUNG

# 1/2

## INSTALLATION INSTRUCTION

**1**

on hard surface

1 m / 40 Zoll  
< 2 mm ↑ 1/8 Zoll

**2**

light

underfloor heating  
water or electric  
surface temp. 27°C

**3**

no!

**4**

tools

**5**

15°C to 26°C

GLUE

24 h hours

acclimatize

**6**

DIN 18365, EN 1264  
CA 0,3 CM %  
CT 1,8 CM %

read the information

**7**

x > 300 mm

cut & break

**8**

starting line

always 1 direction

x = 2 mm

**9**

read the information

**10**

glue the panels

**11**

4 + 5 + 6

**12**

after 20 - 30 min

roll on

**13**

new

**14**

x = 2 mm

between elements

**15**

cut

Ø + 4 mm

**16**

glue on the wall  
without glue !!!

**17**

clean the floor

yes! no!

H<sub>2</sub>O

**18**

max. 30 kg/cm<sup>2</sup>

24 hours ready to use

48 hours

**19**

Type w soft

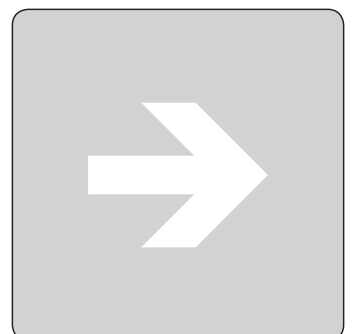

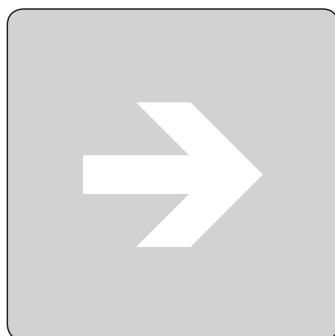

20

### WICHTIG

Bitte Verarbeitungshinweise des Klebstoffherstellers unbedingt beachten!

### IMPORTANT

Please follow up the processing instructions from the glue manufacturer!

YES

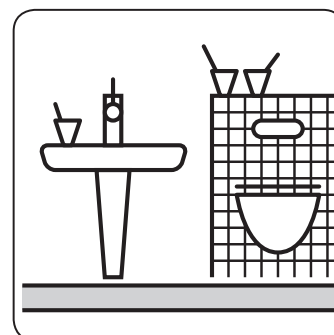
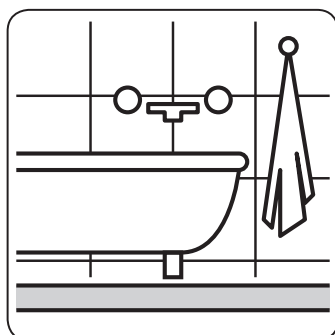

Bei Verlegung in Nassbereichen bitte  
**DIN 18534** beachten.

Installation in wet areas please see **DIN 18534**.

NO

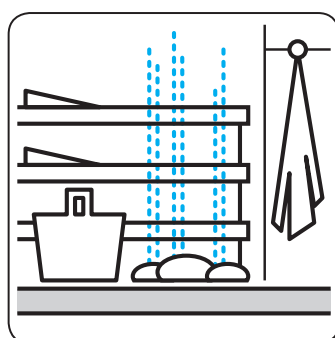
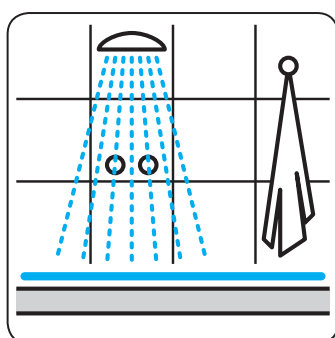
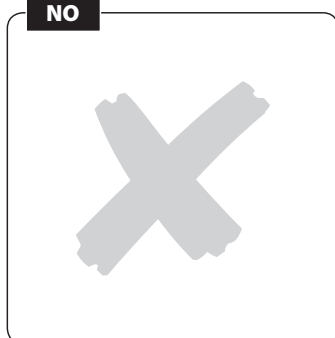

FALQUON GmbH  
Am Hünengrab 18  
D-16928 Pritzwalk  
Gewerbegebiet Falkenhagen  
+ 49 33986 502110 / info@falquon.de  
www.falquon.de / www.the-floor.eu

  
**FALQUON**  
floors for friends